



World Society for the Protection of Animals

COMPANION & WORKING
ANIMALS UNIT

Surveying roaming dog populations: guidelines on methodology

Discussion document: feedback welcomed through discussion group at <http://groups.google.com/group/dog-population-survey-guidelines>.

Aim: The aim of this document is to provide detailed guidance on how to carry out a count of dogs roaming in public areas, as the basis for planning or evaluating a dog population management intervention. There is also additional discussion on potential methods of monitoring the dog population once the intervention has begun and temporary or permanent marking of dogs becomes suitable. The methods selected have been chosen because they require a minimal investment of resources and yet can provide reliable data.

www.wspa-international.org

Contents

Introduction	3
Why do we need to survey the dog population?	3
Counting dogs in public areas	4
An indicator or an estimate?	4
Indicator counts	4
From indicator counts to evaluation	5
Counts leading to an estimate	6
Sampling	6
<i>Selecting a sample of blocks</i>	6
Counting within a selected block	10
Calculating the number of roaming dogs from the count	11
<i>Estimating the total using the sampling fraction</i>	11
<i>Estimating the total using covariates</i>	11
Dogs not roaming at the time of the count	13
Monitoring once intervention has begun	14
Counting once the intervention has begun	14
Marking once the intervention has begun	14
Monitoring interventions where owners bring their dogs	14
Monitoring interventions that catch dogs on the street	15
Conclusions	16
<i>Annex 1 Worked example: From counts to population estimates with confidence intervals</i>	17
<i>Annex 2 Calculating the t-statistic</i>	20

Companion & Working Animals Unit
World Society for the Protection of Animals
89 Albert Embankment
London SE1 7TP
Tel: +44 (0)20 7557 5000
Fax: + 44 (0)20 7703 0208
Email: wspa@wspa-international.org
Website: www.wspa-international.org



Introduction

These guidelines are the result of a project commissioned by the World Society for the Protection of Animals (WSPA) to develop survey methods for roaming dogs that require only a limited investment of resources. The project was conducted by Conservation Research Ltd using surveys in Cairo, Dar es Salaam and Colombo with further small-scale trial surveys in Jaipur and Jodhpur, over the period 2005-7¹. The primary purpose of the guidelines is to support organisations and authorities that are responsible for the management of dog populations and require information on those populations in order to plan or evaluate interventions.

In this document, **roaming dogs** are defined as dogs that are on public areas and not currently under direct control. This term is often used inter-changeably with 'free roaming', 'free ranging' or 'stray' dogs. Note that this term encompasses both owned and unowned dogs; it does not distinguish whether or not the dog has an 'owner' or 'guardian'. Indeed, in many countries the majority of dogs that would be defined as roaming do have an owner but are allowed to roam on public property for part or all of the day.

These guidelines focus on estimating or monitoring simply the total number of roaming dogs in public areas at any one time. For planning and evaluation of an intervention additional information is required, such as the proportion of roaming dogs that are owned, however for the following reasons, the number of roaming dogs was considered a priority. Firstly, the perception that a dog population poses a serious problem is often related to the population density of roaming dogs, yet initial estimates of that density can differ wildly. Secondly it is possible to investigate the number of roaming dogs prior to any intervention with a very limited investment of resources. Thirdly an observed change, or lack of change, in the number of roaming dogs is likely to be taken as one of the most convincing types of evidence for the effectiveness, or lack of effectiveness, of the intervention. Yet methods for direct estimation of roaming dog numbers appear to have received relatively little attention.

Following a detailed description of a method for estimating the number of roaming dogs, potential methods to employ once an intervention has begun are briefly considered.

Most of the methods described in this document are simple to understand and carry out; where we have described a method or calculation that goes beyond the basics we have indicated this section with the symbol **Basic plus**. However, we encourage readers to explore these sections with the aim of utilising these methods and calculations, as they will provide a better quality of information. The discussion group is available for further questions and support.

Why do we need to survey the dog population?

There are three main reasons for surveying the roaming population:

- To assess the **need** for intervention. This usually involves comparing areas within a city or comparing different urban areas in order to prioritise where intervention is needed. Areas with the greatest number or density of roaming dogs may be chosen as priority areas; however other factors (e.g. the frequency of complaints about dogs, or welfare problems experienced by dogs in certain areas) may also be important for prioritisation.
- To **plan** an intervention. Counts of the roaming population can be combined with questionnaire surveys to indicate what factors are most significant in maintaining the roaming dog population and hence the type and size of intervention needed. This will dictate the resources required and may suggest targets that should be set to evaluate progress.
- To **evaluate** the intervention. Once an intervention is in progress further surveys may be able to detect changes in the number of roaming dogs and indicate, in combination with other factors such as bite incidence and disease prevalence in the dog population, the effectiveness of the intervention.

¹ Feedback on this document will be very gratefully received through the discussion group at <http://groups.google.com/group/dog-population-survey-guidelines>.

Counting dogs in public areas

An indicator or an estimate?

There are two main ways of using counts to assess roaming dog populations:

- Collecting an **indicator** of the roaming population (sometimes referred to as an *index of abundance*). This is simply a count that, under certain assumptions, is expected to increase or decrease as the number of roaming dogs in the area increases or decreases. It will not tell you how many roaming dogs there are in your area but a repeat count 12 months later can be compared to the original count to indicate if the number of roaming dogs has been reduced.
- Calculating a population **estimate**. This may be for an entire city or for part of a city such as a specific municipality. Counts made in selected regions are combined to estimate the total number of dogs roaming on public property at any one time. This number allows you to calculate statistics such as the density of roaming dogs per unit of area (e.g. “there is an average of 35 roaming dogs per km² in my local municipality”). As with indicators, estimates made at the same time of year in different years can be compared. However with estimates the ‘significance’ of any observed difference can also be calculated. A significant difference in the estimates is one that has a very small (typically less than 5% chance) of being due merely to a variation in the counts.

Each measure can also be split by age, sex and reproductive status:

- **Age:** pups and adults – dogs are normally classified as pups while dependant on their mother for about the first four months. To ensure consistency counters need to compare the way they classify a sample of dogs of different ages.
- **Sex:** males, females and unknown (pups and dogs seen only at a distance may be difficult to sex).
- **Reproductive status** will depend on what methods of neutering and marking are being used locally; lactating females should be distinguishable from non-lactating females, and it may be possible to discriminate castrated males from entire males and spayed females from entire females.

It is possible to include additional categories, such as those that might reflect the welfare status of the population (e.g. presence of a skin condition, lameness or body condition score).

Indicator count

The advantage of an indicator count is that it requires fewer resources to complete than a population estimate. Selecting one or more routes across the city or municipality and counting dogs along those routes could provide an indicator. The selected route would need to be recorded accurately so that the count can be repeated consistently. It should also be as **representative** of the city as possible and avoid potential **confounding factors** that could affect the counts over time:

- **Representative routes.** You should aim to select routes that intersect a variety of different regions of the city or municipality. If your route is restricted to one region there is a risk that local changes in the roaming population may not be a true reflection of what is happening across the entire city. Try also to include different types of streets and open areas in your routes.
- **Confounding factors.** The number of roaming dogs seen on a route will certainly be affected by the time of day and perhaps by the weather and also by the person counting the dogs. It is important to try to reduce the effect of these factors by keeping everything the same, as far as possible (i.e. count at the same time of day, avoid times of unusual weather and have the same people involved). It is also necessary to decide on a consistent counting protocol, for example whether to count dogs seen on side streets or check for dogs under parked cars.

From indicator counts to evaluation

Indicator counts should be relatively quick to complete and could therefore be conducted several times within a year. However, as breeding in roaming dogs is often seasonal, the number of dogs on the street is bound to change during the year. Hence, for evaluation, it is necessary to compare indicator counts taken at the same time of year; so if only a single indicator count is conducted per year, this should always be at the same time of year. A count approximately six weeks after most of the pups are born (peak time of 'whelping') might be the most valuable as this is when the number of pups visible outside the 'den' will be high. At this time the pups from the current year's breeding season can be easily distinguished from dogs at or over a year old produced in previous breeding seasons. The percentage of lactating females during the breeding season also provides a relatively sensitive indicator of the effect of an intervention aiming to change the reproductive capacity of dog populations.

An easy way to view your results is by using **line graphs**. Plot your indicator counts on the y-axis and the date of the count on the x-axis and join the points to reflect the change in population over time, as shown by the example data in figure 1. Include the component counts (females, lactating females, males, pups etc) as well as the total. Counts obtained from more than one route can be displayed on separate plots to see if they indicate the same changes over time.

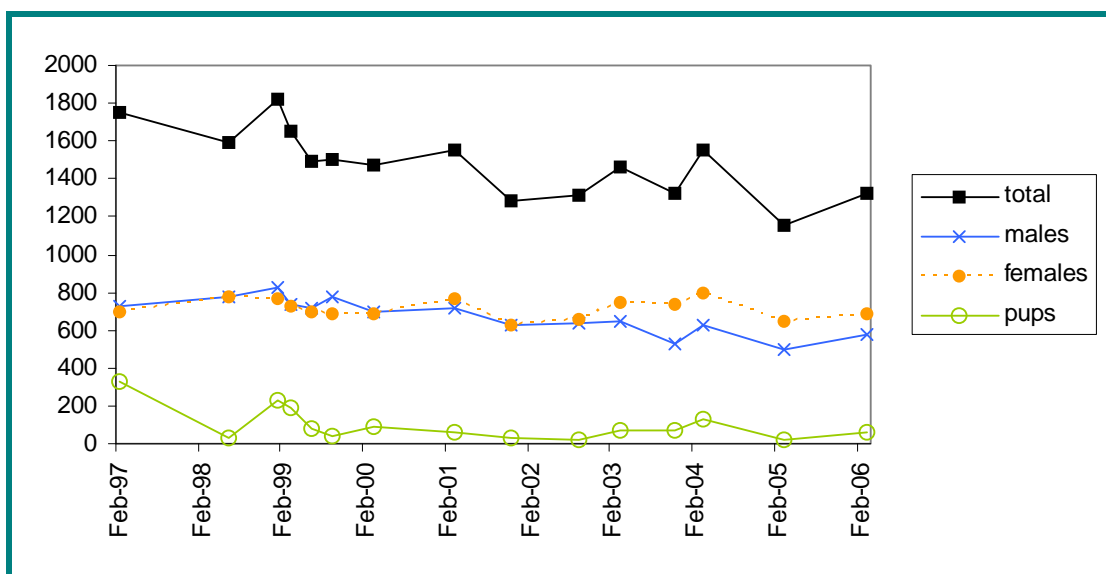

Figure 1. This line graph shows the roaming dog indicator counts made by Help In Suffering in Jaipur (India) over 9 years (<http://www.his-india.org.au>).

Ideally the indicator counts should be repeated on at least three consecutive days (avoiding any days that may show abnormal roaming dog numbers, for example due to unusual weather) to find an estimate of how much the counts vary day-to-day. When the indicator counts are compared across years, any changes in numbers of roaming dogs can then be compared to the day-to-day variation. If the observed year-to-year change is greater than the day-to-day variation, then it is possible to reject normal day-to-day variation as the reason for the observed change in roaming dog numbers.

One disadvantage of indicator counts is that they may be adversely affected by urban development during the intervention period. For example, the roaming population may change locally as open areas are developed for housing, without much change being apparent along routes that do not intersect these new developments. Thus the count may be more sensitive to a change in the ratio of the number of roaming dogs to the human population than to the size of the total roaming dog population itself.

It is difficult to give more definite advice on using indicator counts because so much depends on the circumstances encountered. In general we suggest exploiting opportunities for collecting such counts rather than investing limited resources, for example accepting offers from volunteers to count dogs as they travel to work, or to keep a count of the number of dogs roaming in a local area of waste ground. Information on numbers of roaming dogs over time is often completely lacking so even these sorts of counts can be valuable.

Counts leading to an estimate

Even in a large city, where a total count of roaming dogs would be impractical, it is possible to make an estimate of the total number of dogs roaming within the city limits. The estimate is obtained by counting all the dogs in a random sample of city subregions and extrapolating the count to the whole city, either by dividing the total count by the **sampling fraction** or **relating the sample counts to other variables**. By repeating such a survey years later we may also be able to detect any change in the number of roaming dogs, even if there has been significant urban development during the intervening period.

Sampling

To select a sample the city must first be divided into a set of subregions, which cover the entire region of interest (for example everywhere within the city limits or within a ring road) and are non-overlapping. One method is to use **smallest local authority defined areas**, sometimes called 'wards' or 'boroughs'. This is beneficial if you have other relevant data split by ward such as human population, percentage of main religious types, housing types or services; as these data can be used later to improve the accuracy of the estimate and map the distribution of roaming dog numbers across the city (discussed later). However this will require access to maps showing the ward boundaries in sufficient detail to be located by the counters and, if there has been much development since the ward boundaries were established, it may be time consuming to locate the boundaries.

If there are no relevant data available by ward, the wards are too large or there are no adequate maps available showing the boundaries, the entire city region can be **split into contiguous blocks** (i.e. blocks with no gaps or overlaps between them) using a map that shows the major roads. The blocks do not need to be the same size; ideally they should be chosen to include roughly the same number of roaming dogs, which in practice usually means including roughly equal street lengths – approximately 5 km of street is usually manageable – within each block. A block should take no more than 2 hours to cover; if it takes longer, the block should be split and completed the next day to avoid the confounding effect that time of day may have on the number of roaming dogs. The time required to cover a block will depend on the size, how easy the area is to navigate and how the counting team is travelling (discussed later).

We will use 'block' to mean either block or ward from now on. Figure 2a shows a map of Cairo split into blocks containing roughly equal lengths of street.

Selecting a sample of blocks

The number of blocks selected for the sample will depend on the time and resources you have available. Running test counts in one or two blocks will give you an approximate idea of the time required, and therefore how many blocks you can cover. The more blocks you include in your sample the more accurate your estimate is likely to be. Even if the city is large and the number of sample blocks is only a small fraction of the total number of blocks, it may still be possible to calculate a useful estimate of the total roaming dog population. The accuracy of the estimate is likely to depend more on how much the number of roaming dogs varies between blocks than on the fraction of city blocks covered.

The selection of blocks for the sample should have three characteristics:

- It should be random;
- Each selected block should have a known chance of having been selected for the sample (ideally all should have the same chance of being selected);
- The blocks should be well spread across the city or region, rather than being clumped.

There follows a simple methodology for sample block selection that will achieve these three characteristics.

Method for selecting a sample of blocks:

1. Start by assigning one of four letters (e.g. A, B, C and D) or four colours (e.g. red, blue, green and yellow) to each block. Work outwards from one block roughly in the centre, and never assign the same letter or colour to adjacent blocks (it is a recognised phenomenon in map making that four colours are sufficient to colour all countries without adjacent countries being assigned the same colour). See figures 2a, b and c for an example of this process.



Figure 2a. Central Cairo divided into 108 blocks.

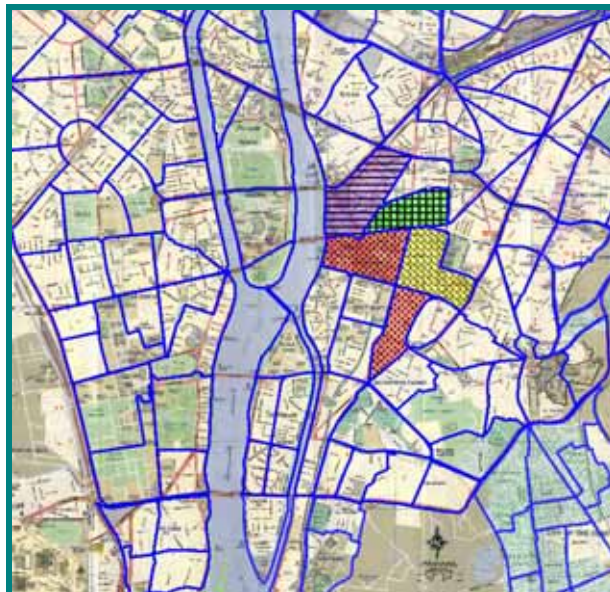

Figure 2b. Starting to colour the blocks in four colours: beginning at the centre and spiralling outwards, never assigning the same colour to neighbouring blocks.



Figure 2c. All 108 blocks assigned one of four colours, with no neighbouring blocks of the same colour and an equal number of blocks of each colour.

- Choose one of the four letters or colours at random; hence selecting all the blocks assigned that letter or colour. This will provide a random sample spread out across the city. Each block's probability of being selected for the sample will be the number of selected blocks divided by the total number of blocks. This will be approximately $1/4$ and exactly $1/4$ if the total number of blocks is divisible by 4. See figure 3 for an example of where one colour (red) has been selected. If this sample is too large to count continue to the next step.



Figure 3. All red blocks selected, each block had a $1/4$ (27 red blocks divided by the total of 108 blocks) chance of being selected.

- Number each of the selected blocks working as much as possible across and down the map, as if reading words from a page. See figure 4 for an example of numbering selected blocks.

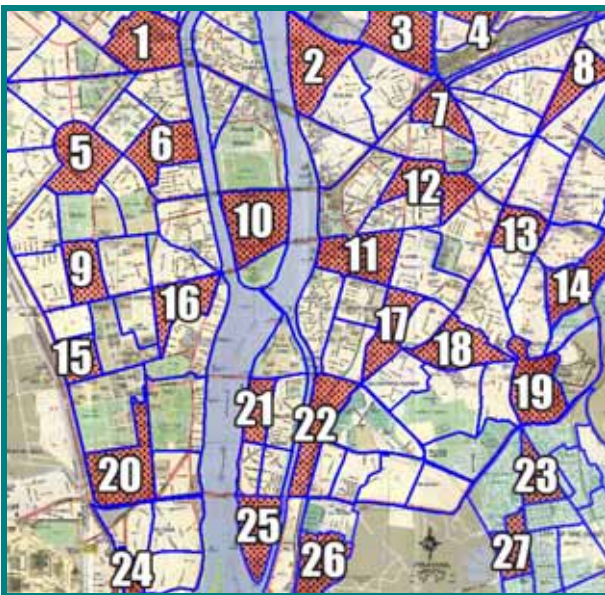

Figure 4. All 27 red blocks numbered in order from left to right and downwards.

4. These numbered blocks can then be selected according to the size of the sample you need. For example, you could choose every other block, so your sample would be $1/2$ of $1/4$ (a sampling fraction of $1/8$). Or choose not to count every third block, so you would be selecting to count in 2 out of 3 blocks, hence $2/3$ of $1/4$ (a sampling fraction $1/6$ of the blocks), see figures 5a and b for an example of this. In order to maintain the random sampling, start with a block randomly chosen from the first possible set; for example if you are selecting every other block, randomly choose the first or second block, if every third block then randomly choose either block 1, 2 or 3. This process means that each block has the same probability (calculated as $1/4$ times the number of selected numbered blocks divided by the total number of numbered blocks) of being included in the sample and the sample blocks will be spread out over the city as much as possible.

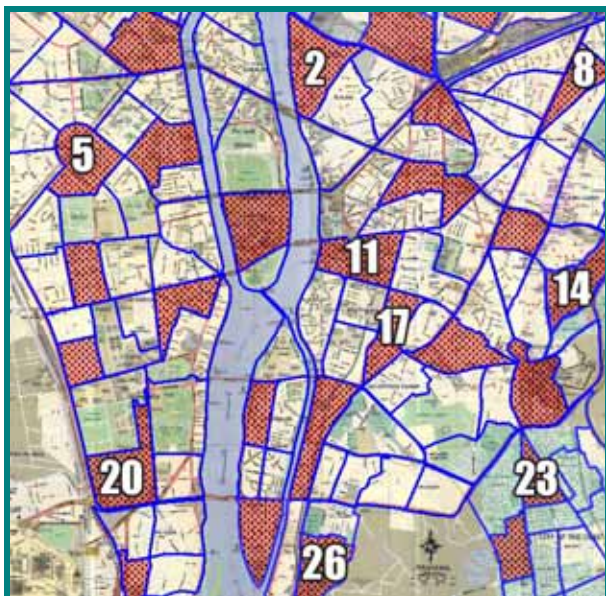

Figure 5a. Every third block has been selected here, starting with a randomly chosen block between 1 and 3, in this case block 2.

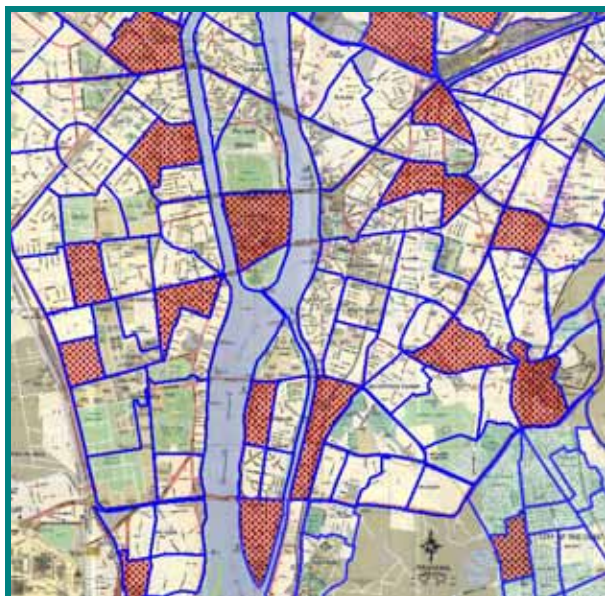

Figure 5b. The blocks selected in figure 5a have been discarded, so $2/3$ of the red blocks remain, hence every block had a $1/6$ chance of being selected (calculated from the original probability of $1/4$ for being a red block, multiplied by the chance of being selected for in the numbering step - $2/3$).

Counting within a selected block

The protocol used to count roaming dogs within a selected block is intended to count all the dogs that are roaming (i.e. not accompanied by an owner) on public property at the time of the count. It is impossible to make an exact count and of course the number of dogs within a block will vary during the count as dogs move in and out across the block boundaries. However it should be possible to get near to the average number within the block during the counting period by following a few simple guidelines, and experience has shown that repeated counts of a block give very consistent results.

The best **time** to start a count is usually at dawn, before garbage is collected, and it should be completed within one or two hours, before the streets fill with traffic; this will ensure the counter sees the maximum number of roaming dogs and can move easily through the streets. This means that a single counter or counting team is unlikely to count more than one block per day. An alternative is to count at night, as was done in Cairo, where most streets are well lit and dogs are active at night.

Detailed street **maps** of the selected blocks are required to ensure that every street is covered. If there are no accurate street maps available, satellite images may provide an alternative (e.g. Google Earth - <http://earth.google.com>). Otherwise it will be necessary to prepare a rough map of the block showing the street layout, which need not be to scale – this could be done at a time unsuitable for counting. Hand-held GPS receivers have been found to have limited use because of loss of signal in narrow streets and under trees (this may change as GPS technology improves), but a simple compass can be useful for orientation in areas of narrow winding streets.

The **method of travelling** should allow you to move quickly but also allow you to search thoroughly. Walking will allow for a thorough count but is slow. Cycling and walking, pushing the bike when required, is a good compromise.

When counting a block there should be an agreed protocol for including dogs at block **boundaries**. One suggested protocol is to include any dog that is to the inside of the centre line of the boundary road when passed by a counter. In this protocol, the counter should not try to include a dog by adjusting their speed in order to pass the dog while it is within the centre line, as this would bias the results.

The counters need to move down every street, counting each dog they see (although sometimes they may be able to observe the entire length of a side street without needing to travel down it). The aim is to be as **thorough as possible**, searching for dogs in potential hiding places (e.g. under cars, in drains) but keeping a **reasonable rate of progress**. Usually the dogs are variable enough in appearance and at a low enough density for counters to avoid double-counting individuals. Keeping a reasonable speed of movement through the block will also reduce the number of times a dog is seen more than once.

A few dogs may be missed as they turn a corner or move out across the block boundary ahead of the counters. However, on average, the dogs counted as they move into the block will compensate for this loss. If dogs are scared off by the counters many will be missed, hence counters should **move quietly and inconspicuously**. It will be necessary to record the category of the dog (e.g. sex and age) as 'unknown' if disturbing a dog to inspect it more closely would cause it to move away from the counters.

Some blocks may contain open public areas such as parks or waste ground. It is usually possible to scan such areas effectively from a vantage point or by walking across them, otherwise **adjacent strip transects** can be used to cover the ground between a minimum of two counters. Two counters move parallel to each other separated by a distance that ensures any dog between them will be seen by at least one counter. The counter on the leading side of the strip counts and records every dog seen in the strip (the area between themselves and the other counter). The other counter can call out to check that the counter on the leading side has noted any dogs that may be hidden from his/her view. At the end of each strip, the counter on the leading side turns around and follows the same path back, but the other counter 'leap-frogs' to what becomes the leading side of the second strip. This counter then counts and records for the second strip, while the other counter marks where the other edge of the last strip lies and, again, alerts the counter on the leading side to any hidden dogs. If audible communication between the counters is difficult this can be done when one 'leap-frogs' past the other at the end of each strip. This process is repeated until the whole area is covered. Figure 6 shows this protocol diagrammatically.

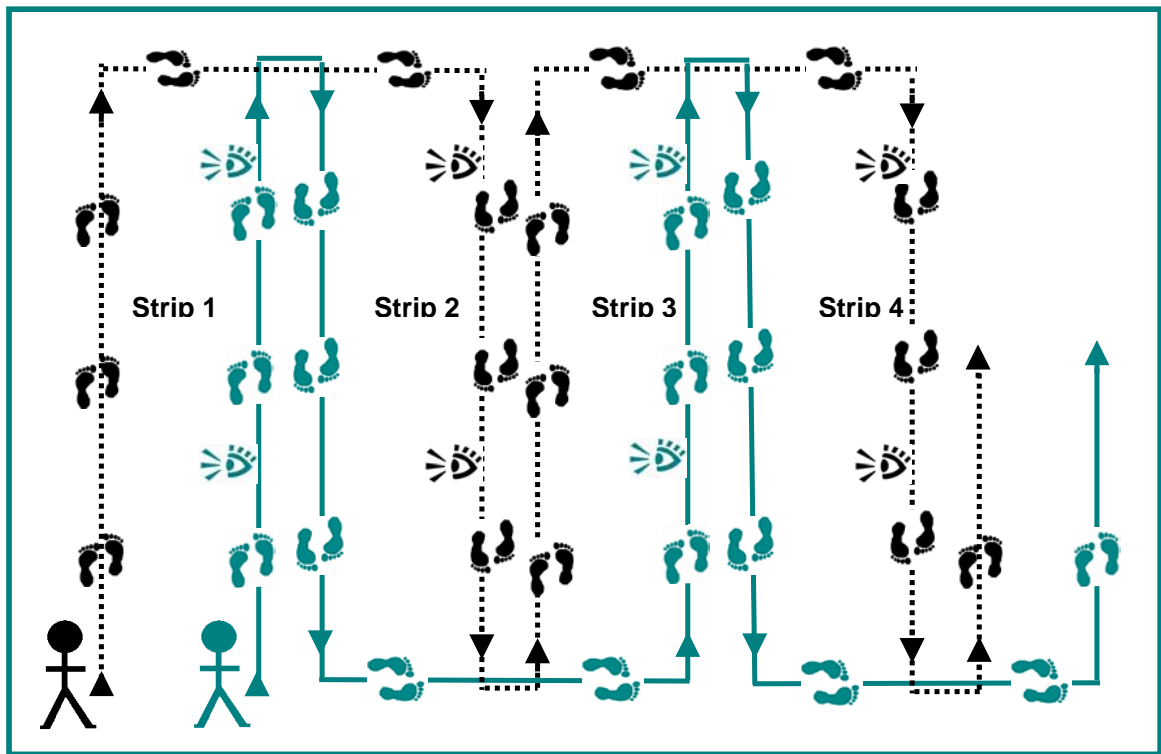

Figure 6. Diagram showing adjacent strip transect method of counting with two observers.

Calculating the number of roaming dogs from the count

This section explains two methods of calculating the estimated total number of dogs in the region from the number of dogs counted in the sample: using the sampling fraction and using covariates.

Estimating the total using the sampling fraction

One way to estimate the total number of dogs roaming in the city at the time the counts were conducted is to divide the total number of dogs counted in the sample blocks by the sampling fraction. Because the sample blocks were randomly selected with equal probability, the estimate is unbiased. That means that if we repeated the sampling and counting process frequently we would get the right answer on average. So for example if the city was covered by 200 blocks and roaming dogs were counted in a random sample of 20 of those blocks, the estimate would be the number of dogs counted divided by 20/200 (or 10 times the total count), see annex 1 for a worked example.

Note that the above method does not use the area of the selected blocks or the area of the city in its calculation of the number of roaming dogs. Area is a possible 'covariate' as discussed later but tends to correlate poorly with roaming dog numbers (street length within a block, for example, tends to correlate more closely to the number of roaming dogs in the block). Calculating the number of roaming dogs per unit area within the sample blocks and then multiplying by the area of the city does not give an unbiased estimate, unless the chance of selecting a block is proportional to its area, and hence is not recommended.

Obviously any one count will not give exactly the right total number of roaming dogs, but you can estimate how close it is likely to be to the true total by using the sample counts to calculate the **standard deviation of the estimate**. This is calculated from a measure of the spread of the counts (called the variance) and the sample size; hence it takes into account how much the number of dogs varies from block to block and the number of sample blocks chosen to count in. See box 1 and the worked example in annex 1 for how to calculate the standard deviation of the estimate.

For a sample of 20 blocks or more the estimate has less than a 5% chance of being more than about two standard deviations away from the correct answer². This is often quoted in terms of **95% confidence intervals**, where the estimated number of dogs for the region is followed by that estimated number minus two times its standard deviation and plus two times its standard deviation. This means that you can be 95% certain that the true number of roaming dogs lies between those limits. This calculation is actually conservative in that it assumes the sample is drawn from an infinite number of blocks whereas the number of blocks covering the city is finite, so any sample goes part way to a complete census. It also assumes a simple random sample was taken whereas the recommended sampling method ensures a more even spread across the city, which will reduce the effect of any trends in roaming dog density across the city. In other words the estimate should be at least as accurate as the standard deviation calculation suggests.

Estimating the total using covariates

The alternative approach to calculating the total number of dogs roaming in the region is to relate the sample counts to one or more **covariates**. These are variables that are related to the number of dogs in some way, for example the number of houses or number of people living in each block. Such information may be available if it is possible to sample wards or boroughs rather than a pattern of blocks based on a road map. This information has to be available for every ward, not just the sample wards. The counts and covariate values in the sample wards are used to calculate a **regression estimator**; the counts in the sample wards are 'regressed' on the covariate values in those wards. We might expect the effect of a chosen covariate on the count to be linear - thus doubling the covariate value should double its effect on the count (e.g. double the people leads to double the number of roaming dogs). However this need not be the case and qualitative variables can also be introduced into the regression equation, for example the presence or absence of an abattoir in the ward. The resulting regression equation is then used to predict the number of dogs roaming in each of the wards that were not selected as part of the sample, which therefore produces a distribution of roaming dog numbers over the city and a total number for the city.

The theory of regression estimators is beyond the scope of this document and our experience with using this approach is currently limited. There are, however, many potential advantages to using this method. These include: producing an estimate of how the number of dogs varies across the region (spatial distribution); improving the accuracy of the estimate; and revealing relationships that might be relevant to the intervention. As an aid to using the approach with real count data and testing it on simulated data, the following link can be used to download software that we have written for calculating regression estimates under various assumptions: www.conservationresearch.co.uk (click on the 'straydog' link). The installation includes a guide on using the software.

BOX 1

Calculating the standard deviation of the estimate:

1. The mean of the sample counts is the total number of dogs counted in the selected blocks divided by the number of selected blocks.
2. The variance of the sample counts is the average of the squared difference between the counts and their mean value.
3. The standard deviation of the counts is the square root of the variance.
4. An estimate of the standard deviation of the average count is the standard deviation of the counts divided by the square root of the sample size.
5. In order to get the standard deviation for the estimated number of dogs in the city the standard deviation of the average count is multiplied by the total number of blocks.

See also worked example in annex 1.

² The exact value to be used to calculate the 95% confidence interval is called the 't-statistic' and depends on the sample size (the number of blocks you have counted in). Annex 2 provides a table of t-statistic values listed against sample size.

Dogs not roaming at the time of the count

A block may contain dogs that do sometimes join the roaming population but at the time of the count are on private property. If the survey is intended to provide an estimate of roaming dog density at the time of the count, purely as one evaluation measure, then failing to include such dogs does not matter. For planning an intervention, however, an estimate of the total number of roaming dogs, and the proportion that are owned, is required.

We suggest the use of questionnaire surveys to estimate the number of roaming dogs not included in the counts (and to obtain the other types of information required for planning). Owners are asked to identify dogs that have access to the street and at what times these dogs roam. The survey responses can be used to estimate how many dogs were not counted because, although they roam, they were on private property at the time of the counts. They can also be used to estimate what percentage of the dogs counted on the streets are owned.

When questionnaire surveys are used, areas such as car parks, factories and temple grounds can be included either in the sampling framework of the questionnaire survey or in the counts. Where there is easy access to an area such as a car park we suggest it should be included in the counts – a guard or caretaker will usually be willing to help in assessing the number of dogs currently within the area.

Basic plus

If the resources for a questionnaire survey are lacking, it is possible to use another method to estimate how many dogs are not visible at the time of the count, called a **sight-resight experiment**. The simplest approach is to identify a number of the dogs seen during the first count (by recording descriptions or by taking digital photographs) and then record what percentage of those dogs are seen during a second count of the same block. Note that it is not necessary to identify all the dogs seen on the first count, only a sample of the most distinctive. Thus the method is quick and simple, which is important if resources are limited. The percentage of the identified dogs not seen on the second count provides an estimate of the percentage of dogs that are not visible on any one count. For example, on day one you see 45 dogs in a block and you identify and make records of 20 of the most distinctive. When you return and count the same block on the second day you only see 15 ($15/20 \times 100 = 75\%$) of those 20 identified dogs. This suggests that on any one count you only see 75% of the roaming dogs that live in that block and, if you searched thoroughly, you can assume that this is because the other 25% were on private property at that time. Hence for the block where you counted 45 dogs, you can estimate there were another 15 dogs on private property at the time of counting and hence a total population of 60 roaming dogs.

However, this experiment only works if a number of assumptions hold. One of the assumptions is that search effort was equal during both counts, which should present no difficulty. However another assumption is that all dogs that roam in the block are equally likely to be seen on your count, which clearly fails if, for example, some only roam occasionally at the time of the counts and others roam nearly all the time. There are ways of reducing that effect but they require a longer sequence of counts over several days, which is time-consuming and increases the risk of including dogs that migrate into the block from adjacent blocks, hence leading to an inflated estimate of the total population size.

The loss of some of the identified dogs to adjacent blocks by the time of the second count may mean that too few are seen on the second count. One way to reduce that effect would be to extend the search to the adjacent blocks but again that would be time-consuming and it is not known how far the search would need to be extended. Another approach is to use a third count to estimate simultaneously the percentage of roaming dogs seen and the percentage that remain within the block from one count to the next. A 'SightResight' program can be downloaded from the 'straydog' link on www.conservationresearch.co.uk to calculate those estimates. It assumes however that identified dogs leaving the block do not return before the third count – continuous mixing across boundaries will still result in an underestimate of the fraction of roaming dogs seen. In summary, the use of sight-resight methods may give an under or overestimate of the fraction of roaming dogs seen and it is generally more useful if the direction of any likely error is known. (Note: if a sample of distinctive dogs is identified it would be worth retaining those records carefully because they could be used over much longer intervals to estimate the survival of roaming dogs).

Monitoring once the intervention has begun

Counting once the intervention has begun

Once an intervention has begun, the number of roaming dogs can be monitored using the counting methods described. The section 'From indicator counts to evaluation' explains how indicator counts can be used for monitoring and evaluation once an intervention has begun. Counts suitable for estimating the total population are likely to take too long to repeat every year. However, they could be repeated after a number of years to reveal in detail how the population has changed. In the intervening years, a limited count can be repeated more frequently in selected blocks. The selected blocks would ideally include both those that are covered by the intervention and those that are yet to be reached by the intervention.

Marking once the intervention has begun

Once intervention has begun there is also the potential to **mark** a sample of dogs and, with limited extra effort, obtain various types of information, depending on the type of marks applied (temporary or permanent, and whether they allow individual identification) and the type of intervention (owned dogs or roaming dogs collected from and returned to the street).

There is extensive literature on the analysis of mark-recapture data and here we have done no more than offer a few suggestions appropriate to the roaming dog situation. Clearly it is valuable to know what percentage of roaming dogs have been processed by the intervention as it proceeds and to be able to distinguish dogs that have been processed from those that have not, both to compare their welfare status and to try to see whether there is a difference between the type of dogs that are being collected and those that are not.

Monitoring interventions where owners bring their dogs

A number of papers (for example, Matter *et al*³ and Kayali *et al*⁴) describe a method for estimating numbers of unowned, owned confined and owned unconfined dogs by using collars to temporarily mark owned dogs brought to a temporary clinic for rabies vaccination. Shortly following the intervention a number of surveys are conducted to count marked and unmarked dogs on the street and a household survey is conducted to determine the fraction of owned dogs that are marked and obtain information on the confinement of marked and unmarked owned dogs. The published accounts suggest using Bayesian statistics to incorporate prior information on confinement and the proportion of dogs seen during street surveys. However, the use of Bayesian statistics is not essential to the technique and two programs can be downloaded from the "straydog" link at www.conservationresearch.co.uk can be used to estimate the numbers of owned and unowned dogs without the need to assign prior probabilities. The link provides information on how to run the programs on real data and how to test them on simulated data. The difference between the "temporary_mark_population" and "temporary_mark_population1" programs is that the latter relaxes the assumption (used in Matter *et al*³ and Kayali *et al*⁴) that unconfined owned dogs are as likely to be seen on the street as unowned dogs. In a fully urban environment that assumption is unlikely to hold as owned dogs with access to public areas may nevertheless be on private property and invisible when the street survey is conducted. In the "temporary_mark_population1" method the household survey is conducted at the same time of day as the street surveys and records the numbers of unconfined owned dogs on the street and within the household at that time.

For owned dogs it may be possible to estimate survival using questionnaire surveys, using information on the fate of dogs owned 12 months before the survey, pups born within the last twelve months and, under certain assumptions, the frequency distribution with respect to age of dogs owned currently. Those methods are available using responses collected over a single questionnaire survey, a follow-up survey or during the household survey conducted as part of the temporary marking method described above. Estimates of survival and pup production can be used to drive a model of the dog population and hence compare observed changes in owned and unowned dog numbers to the expected changes following the intervention.

³ Matter HC, Wandeler AI, Neuenschwander BE, Harischandra LPA, Meslin FX. (2000) Study of the dog population and the rabies control activities in the Mirigama area of Sri Lanka. *Acta Tropica* 75:95-108

⁴ Kayali U, Mindekem R, Yémadji, N, Vouatsou P, Kanninga Y, Ndoutamia AG, Zinsstag J. (2003) Coverage of pilot parenteral vaccination campaign against canine rabies in N'Djaména, Chad. *Bulletin of the World Health Organization* 81 (10)

Monitoring interventions that catch dogs on the street

If dogs are caught in public areas rather than being brought to the clinic by owners they may be given a permanent mark, the most common example being ear notches or tattoos applied to dogs collected for surgical sterilisation. The main function of the marks is to avoid the same dogs being collected again but the existence of permanent marks can also provide valuable information about the population. A virtually cost-free way of collecting that information is to equip staff involved in dog catching with event recorders to record numbers of marked and unmarked dogs they encounter whilst out catching (an event recorder is a mechanical device with buttons that can be pressed each time a dog of a certain type is seen).

From the event recorder, the fraction of dogs seen on the street that are marked can be used to estimate the total number of dogs that roam at any time. The complication here is that as dogs are marked over a period of time some will have died, hence the number of marked dogs remaining at the end of the period is unknown. One option is to use an independent estimate of survival (from published literature) of marked dogs to calculate the number still alive from records of when and where each marked dog was released. In which case, the estimate of the total number of adult roaming dogs is simply the number of marked dogs calculated to have survived to the end of the period divided by the fraction of marked dogs seen on the street at that time.

Alternatively, if marking has been continued at a constant rate over a number of years the population of marked dogs will have reached a constant size, at which annual losses due mortality balance the number of marks added per year. In that case, the estimated number of roaming dogs is that constant population size divided by the fraction of marked dogs seen on the street. For example, if annual survival is 67% and 2000 dogs are marked per year then after a few years the marked population will reach a constant size of $2000/(1 - 0.67)$ or approximately 6000 dogs. If half the dogs on the street are then seen to be marked there must be a total of about 12000 roaming dogs.

Basic
plus

Another source of information, if the mark applied allows individual identification, is a record of the marks carried by any dogs returned to the clinic because they have been collected again by mistake or for veterinary treatment. In this case, it may be possible to estimate annual survival of dogs that have been subject to the intervention by using these marks instead of relying on an independent estimate of annual survival. The frequency distribution of intervals between first and second collection can be used to estimate survival as was done for in Jaipur using data collected over the last ten years (details are in www.biomedcentral.com/1746-6148/4/6).

Even if the marks do not permit individual identification it is possible to estimate survival by monitoring the increase in the number of roaming marked dogs over the first few years following the start of the intervention. As mentioned above, a constant rate of marking will lead eventually to a constant number of marked dogs on the streets. The rate at which that constant number is approached depends on the survival rate: the lower the survival the quicker the approach to the constant level. If S is the proportion of dogs surviving annually, dogs are marked and released at a constant rate of R dogs per year and P is the probability of counting a marked dog on a survey then the expected count at d days after the start of intervention equals

$$\frac{R \times P \times (S^{d/365} - 1)}{\log(S)}$$

There are two unknown parameters, S and P , so a minimum of two counts of marked roaming dogs, for example at the end of the first and second years of the intervention, is sufficient to estimate those parameters. The "permanent_mark_survival" program that can be downloaded from the "straydog" link at www.conservationresearch.co.uk can be used to estimate S and P from up to four roaming dog counts over the first two years of the intervention and to test the estimator. If release of marked dogs into the area used for the roaming dog counts is not constant the program can use, instead of a constant release rate, a record of the number of releases each week from the start of the intervention up to the final count. Details on how to use the program are included with the download. The early years of an intervention thus provide the opportunity to gather essential information about the population being targeted.

Conclusions

Without adequate monitoring of the size of a roaming dog population, how that population is structured and how it is maintained, it is impossible to know if even the best organised and skilfully executed intervention is as effective as it should be, or if and how it should be modified. To obtain sufficient information using the minimum resources (and thus to maximise the resources available for the intervention) it is necessary to exploit the characteristics of the urban environment and the opportunities for data collection offered by the intervention itself.

Splitting an urban environment in to regions of public and private property is usually straightforward and allows the monitoring task to be split into techniques appropriate to each. Public property can be easily subdivided into contiguous blocks to allow sampling and consists largely of major roads, streets and alleys, each of which constitutes a strip transect with dogs visible across its full width. At the right time of day and given adequate maps quite large regions can be covered quite quickly. The way that dogs are distributed will be largely dictated by characteristics of the human population and it may well be possible to obtain information on those characteristics associated with each sample element.

Once intervention has started it provides the potential for temporary or permanent marking and, if dogs are brought by owners, for obtaining information on confinement, age distribution and recent pup production. Additional information can be obtained by questionnaire survey. Where intervention is by collection of dogs from the streets the people involved in that process can provide continuous monitoring of, at least, the ratio of marked to unmarked dogs. Characteristics of the dog population itself can assist in monitoring: variation in size, type and colouring allows sight-resight methods to be used and at least reduces the problem of double-counting and the existence of a distinct breeding season means that surveys can be timed to provide the most sensitive indicators of the effect of the intervention.

The methods described here are considered the most appropriate in order to achieve reliable results for a realistic investment of time and effort. They suggest the following as a possible general approach:

1. Prior to intervention conduct a street count in combination with a questionnaire survey to assess the scale of the required intervention and try to decide whether it should be by owners bringing dogs, collecting roaming dogs off the street, or a combination of both. Exploit available information on seasonal breeding to time the counts to include significant numbers of young pups and lactating females and try to assess the degree to which the roaming dog population is maintained by litters born and raised on the street.
2. If dogs are delivered by owners for vaccination and/or sterilisation, ask those owners about confinement of their dogs and apply temporary marks. Conduct household and street surveys before any significant mark loss and use the "temporary_mark_population" or "temporary_mark_population1" programs to estimate owned and unowned dog numbers. Repeat the exercise after some time, using a different temporary mark (e.g. a different colour collar), to monitor the number of owned and unowned dog numbers. Include questions in the household survey allowing survival and pup production to be estimated and where the intervention includes sterilisation compare observed changes in owned and unowned dog numbers to the expected changes given the number of sterilisations conducted and the survival and production estimates. If temporary marking is not suitable, the methods for counting dogs in public areas described here can be repeated infrequently but regularly as a method of monitoring.
3. If dogs are collected for vaccination and/or sterilisation off the street use event counters to monitor the fraction of permanently marked dogs in each city area. Ensure records of where and when each marked dog is released are maintained. Choose an area where dogs are regularly released and carry out 6-monthly surveys over the first two years to count the number of marked dogs in that area, using consistent effort. Use the "permanent_mark_survival" program to estimate the annual survival of marked dogs and hence calculate the number of marked dogs surviving in each city area for comparison with the fraction of marked dogs in those areas from the event counter counts. This will provide continuous monitoring of roaming dog numbers in the areas where dogs are collected for intervention. Supplement this process with indicator counts in areas where intervention has not yet started to compare changes in intervention and non-intervention areas.

This document will be subject to revision as methods develop and feedback on use of these methods will be gratefully received⁵.

⁵ A discussion group on this document has been set up at <http://groups.google.com/group/dog-population-survey-guidelines>.

Worked example:***From counts to population estimates with confidence intervals***

The following worked example uses fictitious data to work through how you would use the results of counts to estimate the roaming dog population of a city. It uses the example started in the 'Selecting a sample of blocks' section of this document.

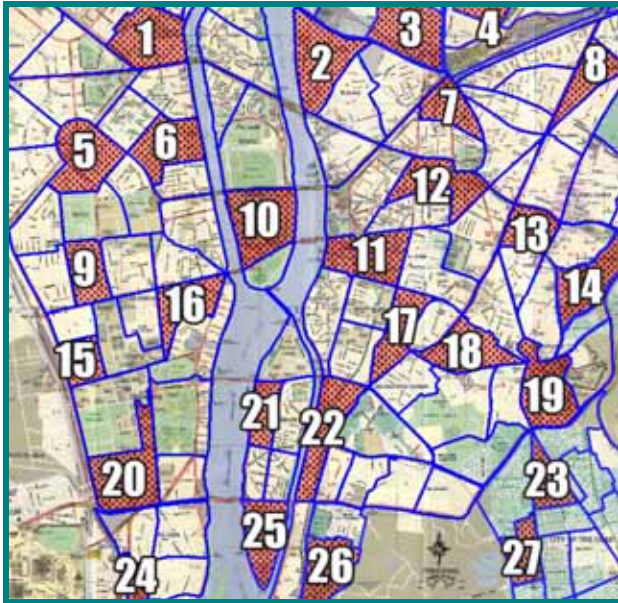

Figure A1. Central Cairo divided into 108 blocks, with 27 blocks selected.

1. 27 blocks were selected as the sample from a total of 108 blocks (figure A1). Counting was carried out over a three week period between the hours of 2am and 6am, as the street lighting in this area was good and this was the period of time when the number of roaming dogs was at its highest. A total of 542 dogs were seen in these 27 blocks.

Calculating the population estimate from the count:

2. The population estimate is calculated by dividing the total number of dogs counted in the sample blocks by the sampling fraction:

$$\frac{\text{total number of dogs counted}}{\text{number of sample blocks} / \text{total number of blocks}} = \frac{542}{27/108} = \frac{542}{0.25} = 2168$$

Between the hours of 2am and 6am there are an estimated 2,168 roaming dogs in this city.

Calculating the confidence intervals for this estimate:

3. Table A1 shows the number of dogs counted in each block, the difference between the number of dogs counted and the mean over the selected blocks (see stage 4 for calculating the mean) and that difference squared.

4. Calculating the mean (average) number of dogs counted per block; total number of dogs counted in the selected blocks divided by the sample size:

$$\frac{\text{total number of dogs counted}}{\text{sample size}} = \frac{542}{27} = 20.07$$

5. Calculating the variance of the counts (the average of the squared difference between the counts and their mean value); total of the squared difference between the counts and their mean value (see table A1) divided by the sample size:

$$\frac{\text{total of } (x - 20.07)^2}{\text{sample size}} = \frac{3281.85}{27} = 121.55$$

6. Calculating the standard deviation of the counts; the square root of the variance:

$$\sqrt{\text{variance}} = \sqrt{121.55} = 11.02$$

7. Calculating the standard deviation for the average number of dogs counted; the standard deviation divided by the square root of the sample size:

$$\frac{\text{standard deviation}}{\sqrt{\text{sample size}}} = \frac{11.02}{\sqrt{27}} = 2.12$$

8. Calculating the standard deviation of the estimated number of dogs in the city; the standard deviation of the mean count multiplied by the total number of blocks:

$$\text{standard deviation of mean} \times \text{total number of blocks} = 2.12 \times 108 = 228.96$$

9. Calculating the 95% confidence interval requires the t-statistic from the table in annex 2, with a sample size of 27 blocks the t-statistic is 2.056; the lower limit of the confidence interval is calculated by subtracting the standard deviation of the estimate multiplied by the t-statistic from the estimated number:

$$\text{estimated number of dogs} - (\text{standard deviation} \times t \text{ statistic})$$

$$2168 - (228.96 \times 2.056)$$

$$2168 - 471 = 1697$$

The upper limit of the confidence interval is calculated by adding the standard deviation of the estimate multiplied by the t-statistic to the estimated number:

$$\text{estimated number of dogs} + (\text{standard deviation} \times t \text{ statistic})$$

$$2168 + (228.96 \times 2.056)$$

$$2168 + 471 = 2639$$

10. Hence, between the hours of 2am and 6am there is an estimated 2,168 roaming dogs in this city. The 95% confidence interval on this estimate is from 1,697 to 2,639 (this means that you can be 95% certain that the true number of roaming dogs lies between these numbers).

Block number	Number of dogs counted (X)	Difference between number of dogs counted and mean (X – 20.07)	Difference between number of dogs counted and mean, squared (X- 20.07) ²
1	8	-12.07	145.68
2	9	-11.07	122.54
3	21	0.93	0.86
4	35	14.93	222.90
5	25	4.93	24.30
6	9	-11.07	122.54
7	33	12.93	167.18
8	39	18.93	358.34
9	27	6.93	48.02
10	9	-11.07	122.54
11	2	-18.07	326.52
12	5	-15.07	227.10
13	29	8.93	79.74
14	8	-12.07	145.68
15	39	18.93	358.34
16	10	-10.07	101.40
17	26	5.93	35.16
18	19	-1.07	1.14
19	13	-7.07	49.98
20	25	4.93	24.30
21	12	-8.07	65.12
22	32	11.93	142.32
23	25	4.93	24.30
24	29	8.93	79.74
25	10	-10.07	101.40
26	31	10.93	119.46
27	12	-8.07	65.12
Total	542		3281.85

Table A1. Number of dogs counted by block, difference between number counted by block and mean and that difference squared.

Annex 2

t-Statistic

When calculating confidence intervals, the value you use to multiple the standard deviation of the estimate is called the t-statistic, use the table A2 below to select your value based on the number of blocks you have counted.

Number of blocks counted	t-statistic
2	12.71
3	4.303
4	3.182
5	2.776
6	2.571
7	2.447
8	2.365
9	2.306
10	2.262
11	2.228
12	2.201
13	2.179
14	2.16
15	2.145
16	2.131
17	2.12
18	2.11
19	2.101
20	2.093
21	2.086
22	2.08
23	2.074
24	2.069
25	2.064
26	2.06
27	2.056
28	2.052
29	2.048
30	2.045
31	2.042
41	2.021
51	2.009
61	2
More than 61 blocks	1.96

Table A2. Shows t-statistics according to number of blocks counted. Multiply the standard deviation by the t-statistic to calculate the confidence interval.